

1 2 3 4 5 6 7 8 9

A

B

C

D

A

B

C

D

E

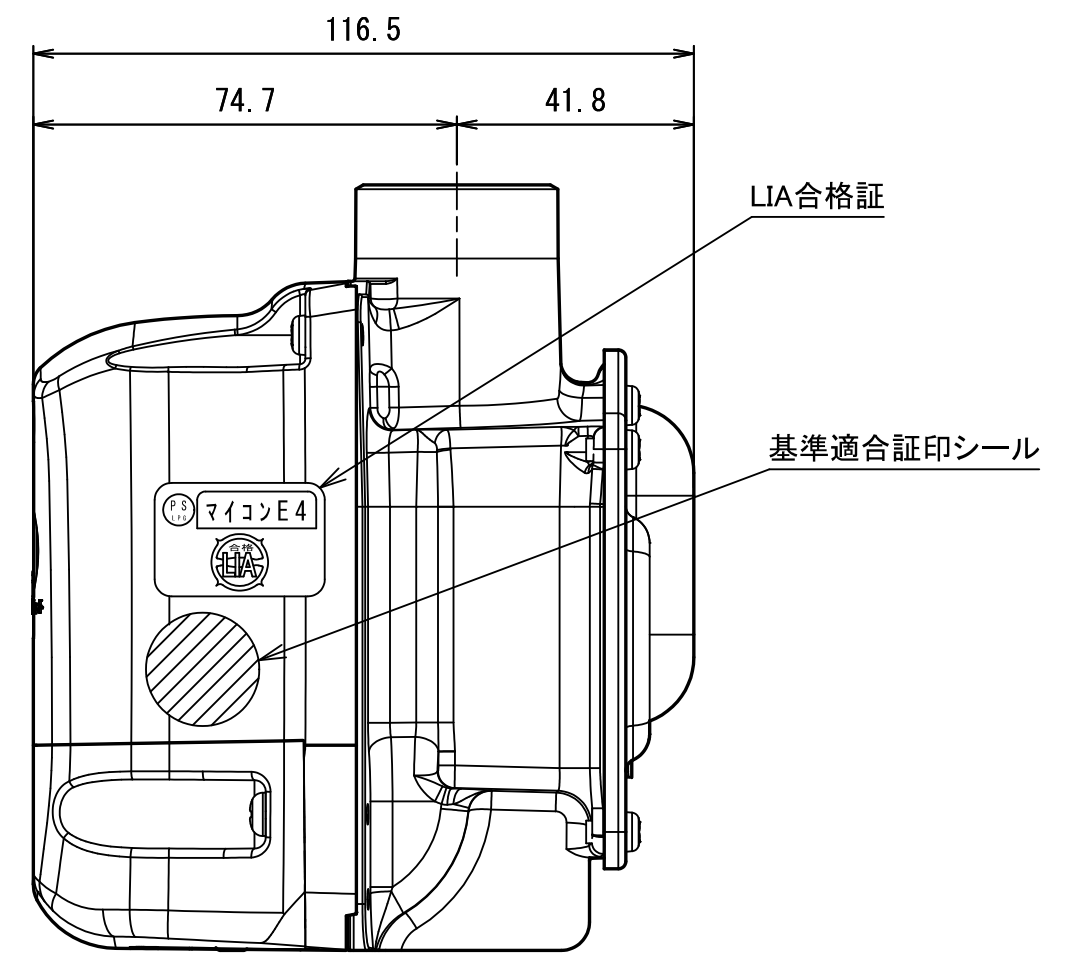
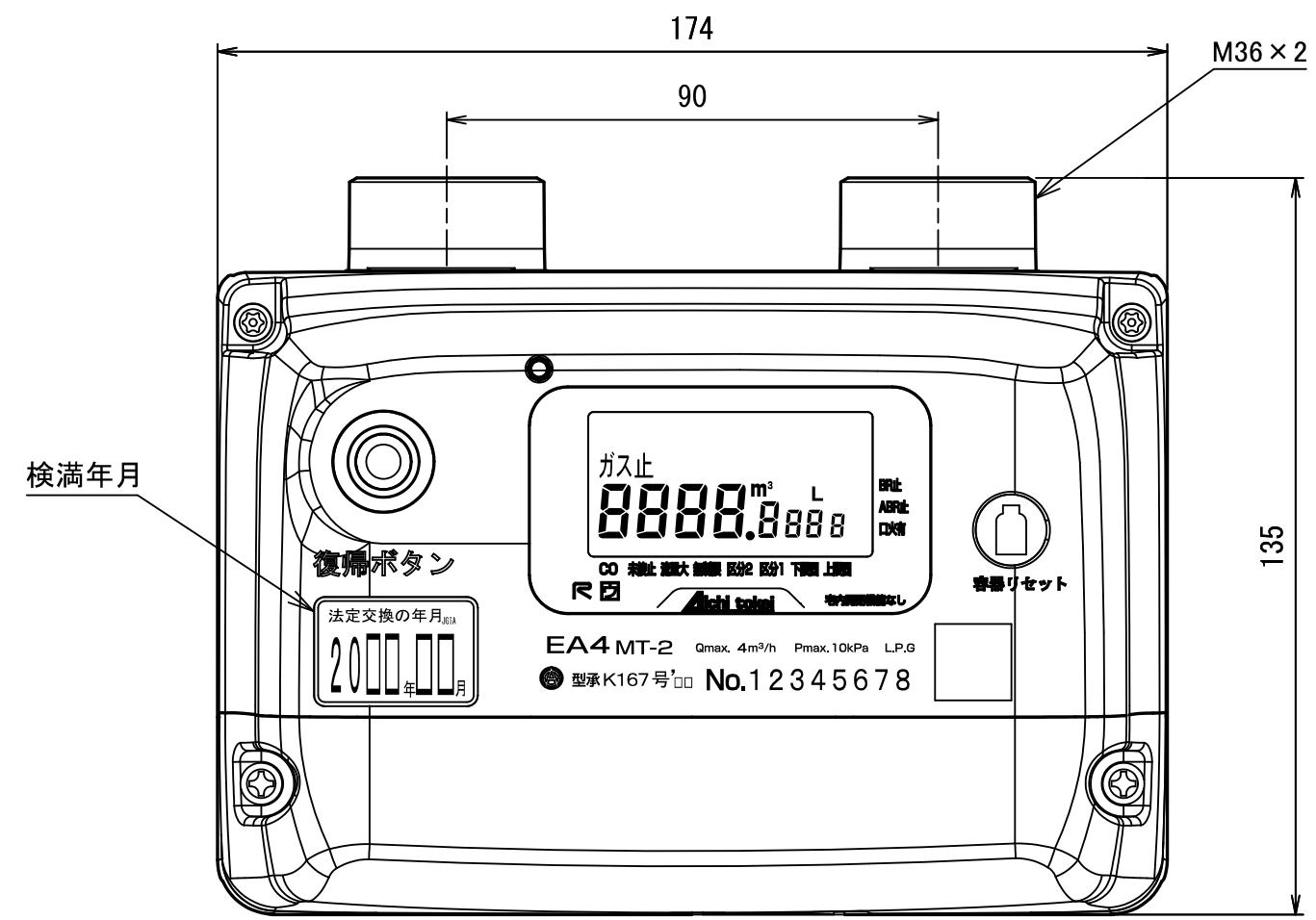
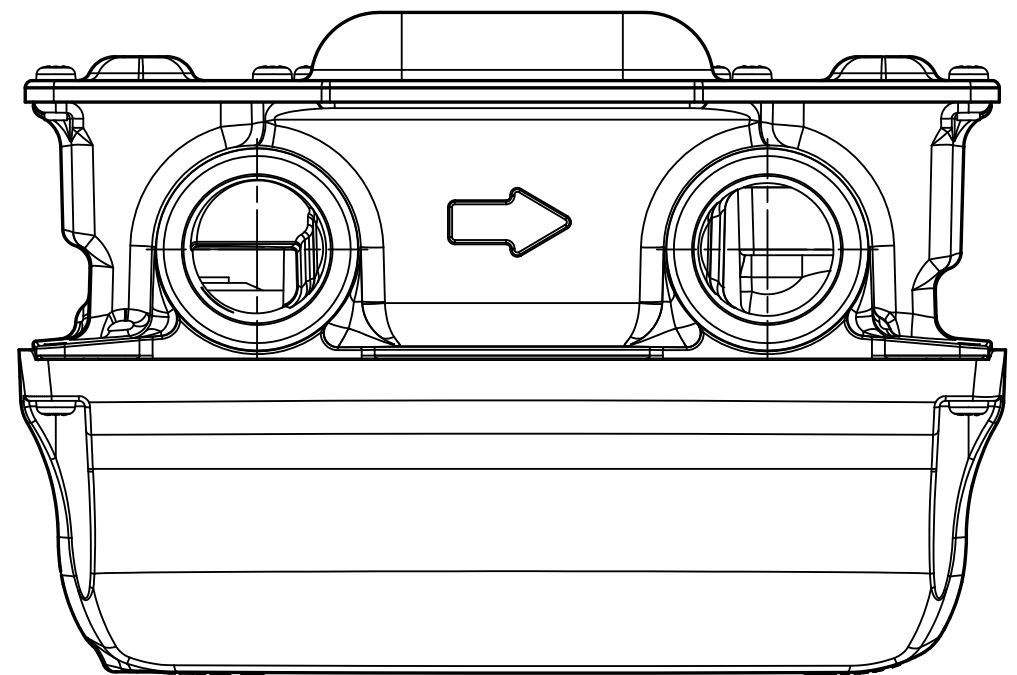

No	D1	D2	C
1			
2			
3			
4			
5			
6			
7			
8			
9			
10			
11			
12			
13			
14			
15			
S			

EA4MT-2
型 式
MODEL

尺度 SCALE	年月日 DATE	名 称 NAME	図 番 DRAWING NUMBER
	2018/12/26	EA4MT-2-ULS外形図	EA04MT-2/1-□□0001

1 2 3 4 5 6